

KOMATSU

PC
210

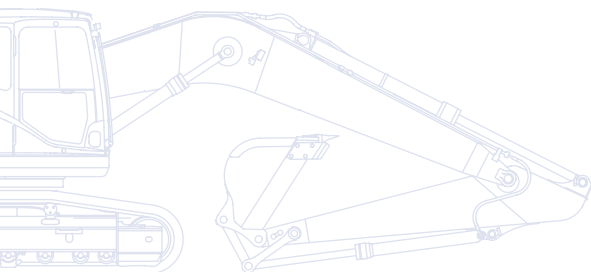

Hydraulic Excavator **PC210/LC-10**



ENGINE POWER

123 kW / 165 HP @ 2.000 rpm

OPERATING WEIGHT

PC210-10: 22.020 - 22.560 kg

PC210LC-10: 22.620 - 23.480 kg

BUCKET CAPACITY

max. 1,68 m³

Walk-Around

Built around the EU Stage IIIB engine platform, Komatsu's latest generation of excavators continues a long tradition of uncompromising quality and total customer support, while renewing a commitment to safety and environmental protection. Increased net horsepower, lower fuel consumption and emissions, and the advanced electronic control system that manages airflow rate, fuel injection and combustion parameters to optimize performance and further reduce particulate matter and nitrogen oxides in the exhaust: you can trust "Dash 10" machines to keep their promises of excellence.

Powerful and environmentally friendly

- Low consumption EU Stage IIIB engine
- Fuel-saving engine and hydraulic technology
- Adjustable Eco-gauge and idle caution
- Reduced wastage



A maintenance program
for Komatsu customers



Komatsu Wireless
Monitoring System

Total versatility

- Ideal for a wide range of applications
- 6 working modes
- Wide choice of options
- Built-in versatility
- Ultimate operator control



PC210-10

ENGINE POWER

123 kW / 165 HP @ 2.000 rpm

OPERATING WEIGHT

PC210-10: 22.020 - 22.560 kg
PC210LC-10: 22.620 - 23.480 kg

BUCKET CAPACITY

max. 1,68 m³

First-class operator comfort

- Fully air suspended operator station
- Low noise design
- Low vibration levels
- Large, widescreen hi-res display monitor
- Improved operator convenience



Highest safety standards

- Safe SpaceCab™
ROPS compliant with ISO 12117-2:2008
- Low profile rear view camera
- Optimal jobsite safety
- Safe access, easy maintenance
- Falling Object Protection System (FOPS) optional



Quality you can rely on

- Reliable and efficient
- Rugged design
- Komatsu-quality components
- Extensive dealer support network

Total Versatility

Ideal for a wide range of applications

Powerful and precise, the Komatsu PC210-10 is equipped to efficiently carry out any task your business requires. On big sites or small, for digging, trenching, landscaping or site preparation, the Komatsu original equipment hydraulic system always ensures maximum productivity and control.

6 working modes

Power, Lifting, Breaker, Economy, Attachment Power and Attachment Economy modes are all available, ensuring that the PC210-10 delivers the power you need with minimised fuel usage. The Economy mode can be adjusted for an ideal balance between power and economy to match your work. The oil flow delivered to hydraulic attachments is adjustable directly on the class-leading wide screen monitor panel.



Built-in versatility

A standard fit additional hydraulic circuit, controlled by a sliding joystick push button and a floor mounted pedal, gives the PC210-10 excellent versatility. Ten attachment memory settings are provided, with individually definable names. In combination with the standard-fit hydraulic quick coupler power circuit, changing working style is now even simpler. A second auxiliary hydraulic line is available for attachments which require extra hydraulic actuation.

A wide choice of options

With a choice of arms and undercarriages, you can configure the PC210-10 to match specific demands for transport, working envelope or duty. Extra hydraulic arrangements are available for every boom and arm configuration, making sure that the machine always contributes strongly to your business.

Ultimate operator control

The PC210-10 comes with a “Topcon ready” option for 3D machine guidance systems. Topcon’s latest technology for precise positioning and machine control, with its easy-to-use GX60 touch screen monitor, reduces work time and enhances job safety. It allows millimetre accuracy when digging or grading and puts the operator in total control of the excavation task.





Powerful and Environmentally Friendly

New Komatsu engine technology

The powerful and fuel-efficient Komatsu SAA6D107E-2 engine in the PC210-10 delivers 123 kW / 165 HP and is EU Stage IIIB certified. To maximise power, fuel efficiency and emission compliance, it is turbo charged and features direct fuel injection, air-to-air after cooling and cooled EGR.

Fuel-saving engine and hydraulic technology

The PC210-10 features variable speed matching of the engine and hydraulic pump, and an automatic low idle. The new engine and pump control technology lower total fuel consumption and guarantee efficiency and precision during single and combined movements.

Adjustable Eco-gauge and idle caution

The new Eco-gauge can be set to target a fuel consumption value, encouraging the operator to work as efficiently as possible. And to further avoid wasting fuel when the machine is not actually working, a standard-fit idle caution is displayed if the engine idles for 5 minutes or more.

Komatsu Diesel Particulate Filter (KDPF)

Komatsu's high efficiency DPF captures more than 90% of particulate matter. It includes a special oxidation catalyst with fuel injection system that can incinerate trapped particulates by either active or passive regeneration with no need to interrupt machine operations.

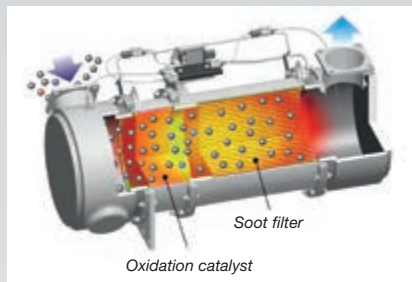

Exhaust Gas Recirculation (EGR)

Cooled EGR is a technology well-proven in current Komatsu engines. The increased capacity of the EGR cooler now ensures very low NOx emissions and a better engine performance.

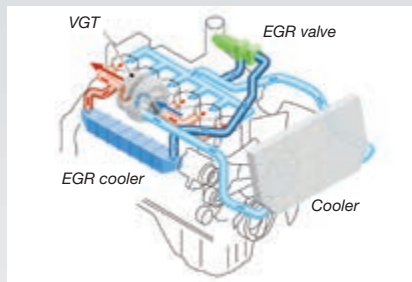

Variable Geometry Turbo (VGT)

The VGT provides optimal air flow to the engine combustion chamber under all speed and load conditions. Exhaust gas is cleaner, fuel economy is improved while machine power and performance are maintained.

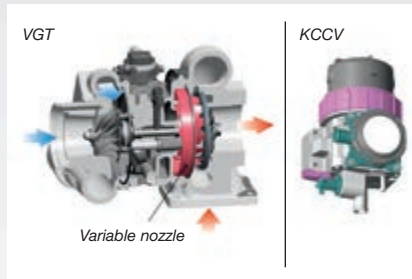

Komatsu Closed Crankcase Ventilation (KCCV)

Crankcase emissions (blow-by gas) are passed through a CCV filter. The oil mist trapped in the filter is returned back to the crankcase while the filtered gas is returned to the air intake.

High-Pressure Common Rail (HPCR)

To achieve complete fuel burn and lower exhaust emissions, the heavy duty High-Pressure Common Rail fuel injection system is computer controlled to deliver a precise quantity of pressurised fuel into the redesigned engine combustion chamber by multiple injections.

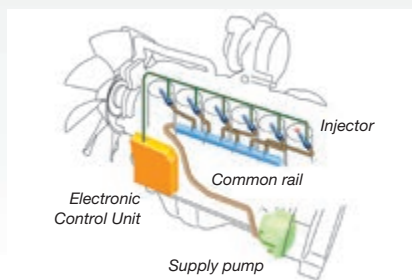

Reduced wastage

Standard equipment on all PC210-10 includes an electric fuel pump, simple to operate and with an automatic shut-off. To further increase the system's safety, a barrier and special foams help to avoid any spilt fuel flowing towards hot areas of the machine.



First-Class Operator Comfort

Newly designed, spacious cab

The wide spacious cab features a new, fully air suspended operator control station that incorporates the side consoles mounted together with a high back, fully adjustable seat, heated for improved comfort.

Improved operator convenience

With increased in-cab storage space, an auxiliary input (MP3 jack) and 12 V and 24 V power supply, the cab offers maximum convenience. The automatic air conditioner allows the operator to easily and precisely set the cab's atmosphere.

Low noise design

Komatsu Dash 10 crawler excavators have very low external noise levels and are especially well-suited for work in confined spaces or urban areas. Reduced fan speed, a large capacity radiator, and the optimal usage of sound insulation and of sound absorbing materials help to make noise levels inside Dash 10 excavators comparable to those inside an executive car.

Cab damper mounting

The built-in stability of the Komatsu PC210-10, combined with a highly rigid deck and a sprung multi-layer viscous mount system, drastically reduces vibration levels for the operator.



Automatic air conditioner



Hot and cool box



Joysticks with proportional control button for attachments



Large, widescreen hi-res display monitor

To enable safe, accurate and smooth work, the user friendly monitor is the highly intuitive user interface for the machine's Equipment Management and Monitoring System (EMMS). Easily customized and with a choice of 25 languages, it features simple switches and multifunction keys that provide the operator with fingertip access to a wide range of functions and operating information.



Highest Safety Standards

Safe SpaceCab™

The new cab is ROPS compliant with ISO 12117-2:2008. It has a tubular steel frame and provides very high shock absorbency, impact resistance and durability. The seat belt is designed to keep the operator in the safety zone of the cab in the event of a roll-over. Optionally it can be fitted with an ISO 10262 Level 2 Falling Object Protective System (FOPS) with openable front guard.

Safe and easy maintenance

Thermal guards are placed around high temperature parts of the engine. The fan belt and pulleys are well protected and in case of damage, fire risk is reduced by a pump/engine partition that prevents hydraulic oil from spraying onto the engine. The engine hood is hinged to the rear, with anti-slip plates positioned around the engine bay to ensure safe and easy access from all sides. Exceptionally sturdy handrails further contribute to a high safety level.

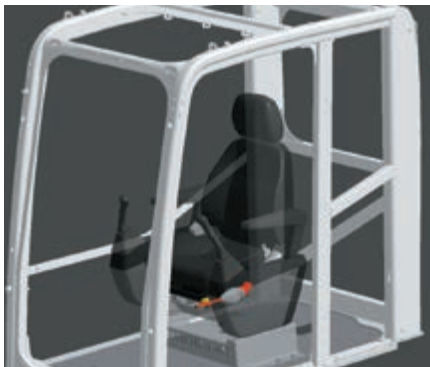

Safe SpaceCab™

Optimal job site safety

Safety features on the Komatsu PC210-10 comply with the latest industry standards and work together as a system to minimise risks to personnel in and around the machine. An audible travel alarm further promotes job site safety. Highly durable anti-slip plates – with additional high friction covering – maintain long term traction performance.

Rear view camera

A standard fitment camera gives an exceptionally clear view of the rear work zone on the wide-screen monitor panel. The low profile camera is adjustable and integrated into the counterweight's shape. On request, another camera can be added to the right side of the machine.



Low profile rear view camera



Large handrails





Quality You Can Rely On

Reliable and efficient

Productivity is the key to success – all major components of the PC210-10 are designed and directly manufactured by Komatsu. Essential machine functions are perfectly matched for a highly reliable and productive machine.

Rugged design

Maximum toughness and durability – along with top class customer service – are the cornerstones of Komatsu's philosophy. Single piece plates and castings are used in key areas of the machine's structure for good load distribution. Highly durable rubbing strips on the underside of the arm protect the structure against material falling from the bucket.

Komatsu-quality components

With the latest computer design techniques and a thorough test programme, Komatsu's global know-how produces machines that are designed, manufactured and tested to meet your highest standards.

Extensive dealer support network

The extensive Komatsu distribution and dealer network is standing by to help keep your fleet in optimum condition. Customised servicing packages are available, with express availability of spare parts, to make sure that your Komatsu will continue to perform at its peak.



Cast boom foot



Single piece boom plates



Komatsu Wireless Monitoring System

The easy way to higher productivity

KOMTRAX™ is the latest in wireless monitoring technology. It delivers insightful and cost saving information about your fleet and equipment and offers you a wealth of information to facilitate peak machine performance. By creating a tightly integrated web of support it allows pro active and preventive maintenance and helps you to efficiently run a business.

Knowledge

You get quick answers to basic and critical questions about your machines - what they're doing, when they did it, where they're located, how they can be used more efficiently, and when they need to be serviced. Performance data is relayed by satellite from your machine to your computer and to your local Komatsu distributor - who's readily available for expert analysis and feedback.

Convenience

KOMTRAX™ helps to conveniently manage your fleet on the web, wherever you are. Data is analysed and packaged specifically for easy and intuitive viewing in maps, lists, graphs and charts. You can anticipate the type of service and parts your machines could require, or troubleshoot problems before Komatsu technicians arrive on site.



Power

The detailed information that KOMTRAX™ puts at your fingertips 24 hours a day, 7 days a week gives you the power to make better daily and long-term strategic decisions. You can anticipate problems, customize maintenance schedules, minimize downtime and keep your machines where they belong – working on the job site.

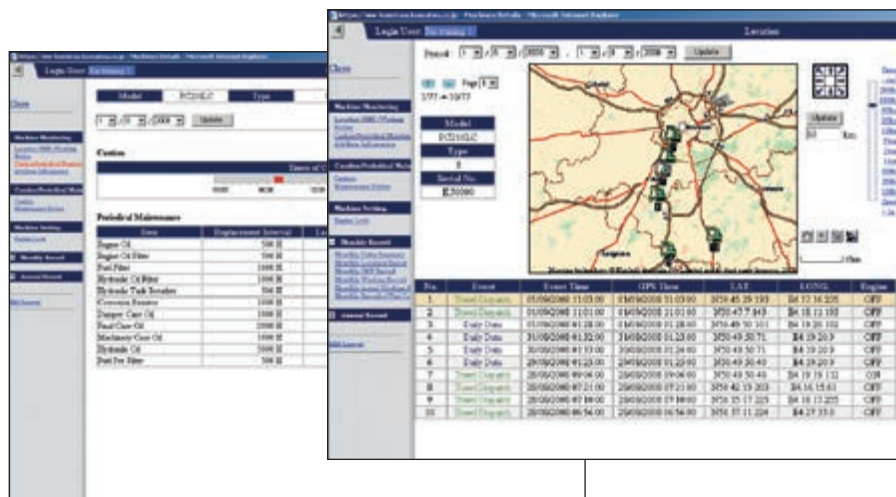

Through the web application, a variety of search parameters are available to quickly find information about specific machines based on key factors such as utilization rates, age, various notification messages, and more.

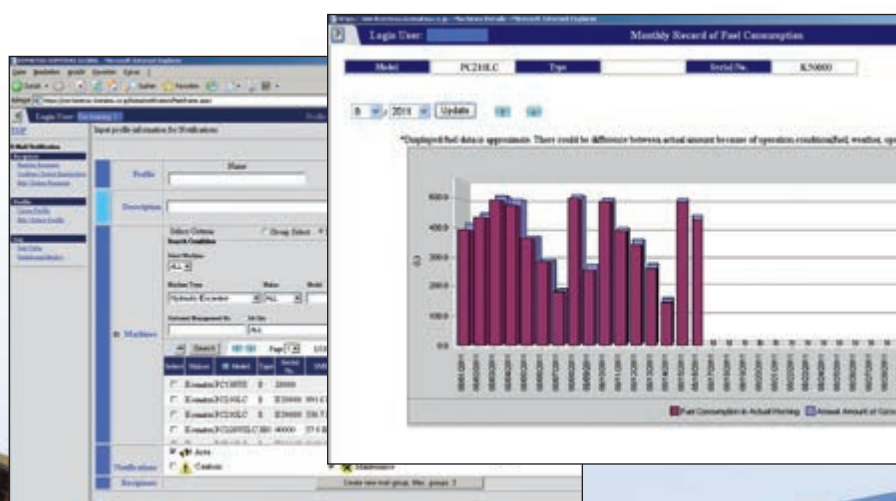

A simple chart shows the machine's fuel consumption and helps you to calculate total costs for a job site and conveniently schedule fuel deliveries.

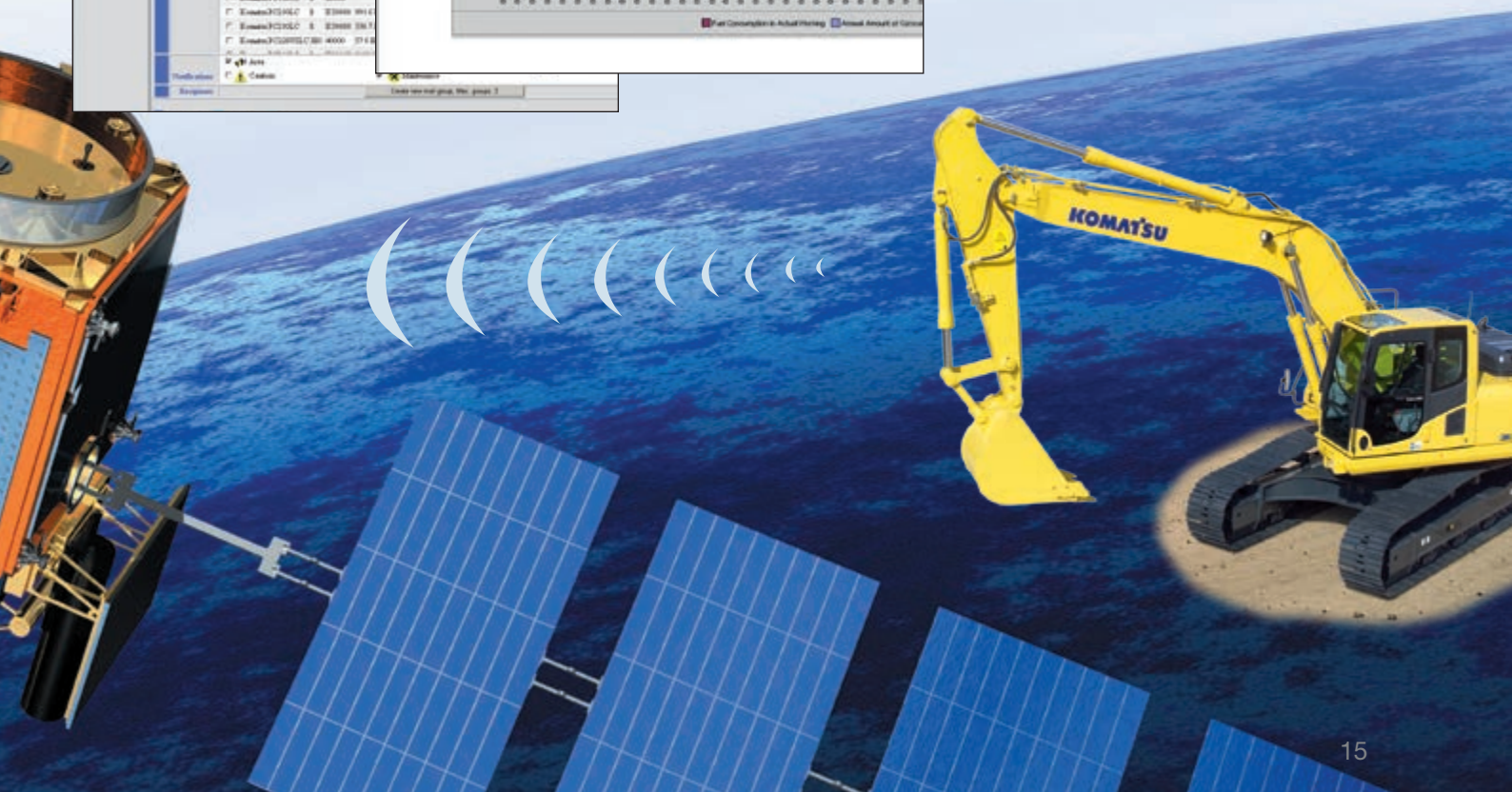

Easy Maintenance

Easy cleaning of coolers

Hinged air conditioning cooler and side-by-side radiator and oil cooler allow easy access for cleaning.



Quick access to filters and fuel drain valve

The engine oil filter, the fuel filters and the fuel drain valve are mounted remotely to make them accessible from ground level.

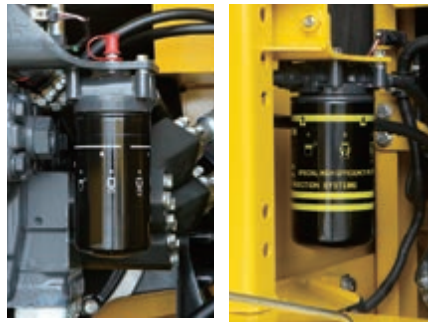

Diesel particulate filter regeneration

Soot trapped in the diesel particulate filter is periodically and automatically oxidized using the heat from the engine exhaust.



Komatsu CARE™ is a maintenance program that comes as standard with your new Komatsu machine. It covers factory-scheduled maintenance, performed with Komatsu Genuine parts by Komatsu-trained technicians. Depending on your machine's engine, it also offers extended coverage of the Komatsu Diesel Particulate Filter (KDPF) or the Komatsu Diesel Oxidation Catalyst (KDOC), and of the Selective Catalytic Reduction (SCR). Please contact your local Komatsu distributor for terms and conditions.

Water separator

This is standard equipment which removes any water that has become mixed with the fuel, preventing fuel system damage.



Long-life oil filters

The hydraulic oil filter uses high-performance filtering material for long element replacement intervals, which significantly reduces maintenance costs.



ENGINE

Model	Komatsu SAA6D107E-2
Type	Common rail direct injection, water-cooled, emissionised, turbocharged, after-cooled diesel
Engine power	
at rated engine speed	2.000 rpm
ISO 14396	123 kW / 165 HP
ISO 9249 (net engine power)	118 kW / 158 HP
No. of cylinders	6
Bore x stroke	107 x 124 mm
Displacement	6,69 ltr
Battery	2 x 12 V/155 Ah
Alternator	24 V/60 A
Starter motor	24 V/5,5 kW
Air filter type	Double element type with monitor panel dust indicator and auto dust evacuator
Cooling	Suction type cooling fan with radiator fly screen

HYDRAULIC SYSTEM

Type	HydrauMind. Closed-centre system with load sensing and pressure compensation valves
Additional circuits	2 additional circuits with proportional control can be installed
Main pump	2 variable displacement piston pumps supplying boom, arm, bucket, swing and travel circuits
Maximum pump flow	2 x 237,5 ltr/min
Relief valve settings	
Implement	380 kg/cm ²
Travel	380 kg/cm ²
Swing	295 kg/cm ²
Pilot circuit	33 kg/cm ²

UNDERCARRIAGE

Construction	X-frame centre section with box section track frames
Track assembly	
Type	Fully sealed
Shoes (each side)	45 (PC210), 49 (PC210LC)
Tension	Combined spring and hydraulic unit
Rollers	
Track rollers (each side)	7 (PC210), 9 (PC210LC)
Carrier rollers (each side)	2

OPERATING WEIGHT (APPR.)

	PC210-10		PC210LC-10	
	Operating weight	Ground pressure	Operating weight	Ground pressure
Triple grouser shoes				
600 mm	22.020 kg	0,51 kg/cm ²	22.620 kg	0,48 kg/cm ²
700 mm	22.270 kg	0,44 kg/cm ²	22.890 kg	0,41 kg/cm ²
800 mm	22.560 kg	0,39 kg/cm ²	23.210 kg	0,37 kg/cm ²
900 mm	-	-	23.480 kg	0,33 kg/cm ²

Operating weight, including specified work equipment, 2,9 m arm, 760 kg bucket, operator, lubricant, coolant, full fuel tank and the standard equipment.

SWING SYSTEM

Type	Axial piston motor driving through planetary double reduction gearbox
Swing lock	Electrically actuated wet multi-disc brake integrated into swing motor
Swing speed	0 - 12,4 rpm
Swing torque	64,6 kNm
Max. pressure	295 kg/cm ²

DRIVES AND BRAKES

Steering control	2 levers with pedals giving full independent control of each track
Drive method	Hydrostatic
Travel operation	Automatic 3-speed selection
Gradeability	70%, 35°
Max. travel speeds	
Lo / Mi / Hi	3,0 / 4,1 / 5,5 km/h
Maximum drawbar pull	20.600 kg
Brake system	Hydraulically operated discs in each travel motor

SERVICE REFILL CAPACITIES

Fuel tank	400 ltr
Radiator	30,7 ltr
Engine oil	23,1 ltr
Swing drive	6,5 ltr
Hydraulic tank	132 ltr
Final drive (each side)	5,0 ltr

ENVIRONMENT

Engine emissions	Fully complies with EU Stage IIIB exhaust emission regulations
Noise levels	
LwA external	102 dB(A) (2000/14/EC Stage II)
LpA operator ear	69 dB(A) (ISO 6396 dynamic test)
Vibration levels (EN 12096:1997)	
Hand/arm	≤ 2,5 m/s ² (uncertainty K = 0,49 m/s ²)
Body	≤ 0,5 m/s ² (uncertainty K = 0,24 m/s ²)
Contains fluorinated greenhouse gas HFC-134a (GWP 1430).	
Quantity of gas 0,9 kg, CO ₂ equivalent 1,29 t	

Dimensions & Performance Figures

MACHINE DIMENSIONS	PC210-10	PC210LC-10
A Overall width of upper structure	2.705 mm	2.705 mm
B Overall height of cab	3.045 mm	3.045 mm
C Overall length of basic machine	4.945 mm	5.135 mm
D Tail length	2.910 mm	2.910 mm
Tail swing radius	2.940 mm	2.940 mm
E Clearance under counterweight	1.085 mm	1.085 mm
F Machine tail height	2.250 mm	2.250 mm
G Ground clearance	440 mm	440 mm
H Tumbler centre distance	3.275 mm	3.655 mm
I Track length	4.080 mm	4.450 mm
J Track gauge	2.200 mm	2.380 mm
K Track shoe width	600, 700, 800 mm	600, 700, 800, 900 mm
L Overall track width with 600 mm shoes	2.800 mm	2.980 mm
Overall track width with 700 mm shoes	2.900 mm	3.080 mm
Overall track width with 800 mm shoes	3.000 mm	3.180 mm
Overall track width with 900 mm shoes	-	3.280 mm

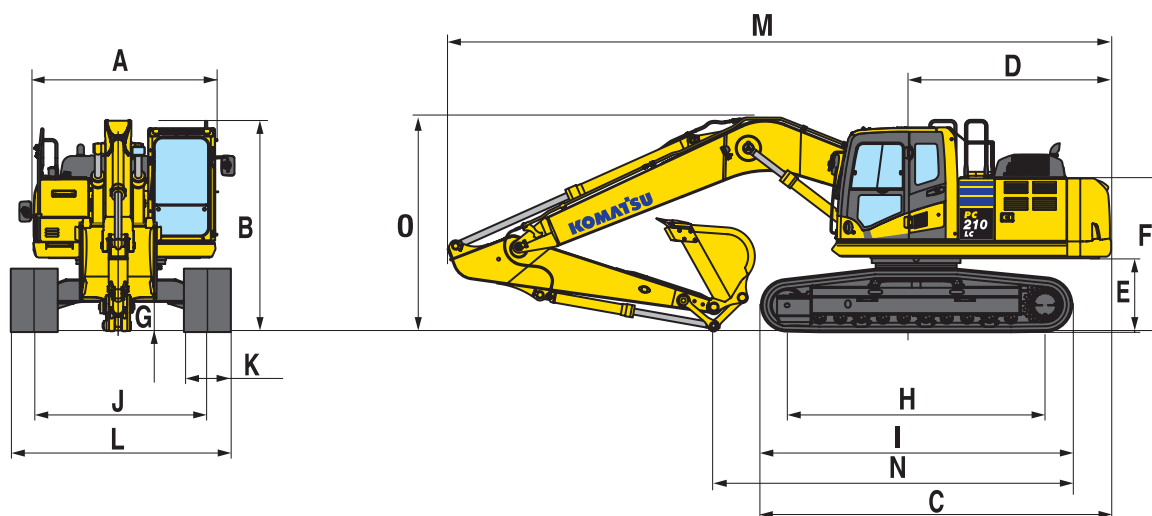

TRANSPORT DIMENSIONS	MONO BOOM	
Arm length	2,4 m	2,9 m
M Transport length	9.695 mm	9.625 mm
N Length on ground (transport) PC210-10	4.070 mm	4.070 mm
Length on ground (transport) PC210LC-10	4.450 mm	4.450 mm
O Overall height (to top of boom)	3.135 mm	3.135 mm



PC210-10 / MAX. BUCKET CAPACITY AND WEIGHT

Arm length	MONO BOOM			
	2,4 m		2,9 m	
Material weight up to 1,2 t/m ³	1,59 m ³	1.125 kg	1,44 m ³	1.050 kg
Material weight up to 1,5 t/m ³	1,35 m ³	1.000 kg	1,23 m ³	950 kg
Material weight up to 1,8 t/m ³	1,10 m ³	925 kg	1,07 m ³	850 kg

PC210LC-10 / MAX. BUCKET CAPACITY AND WEIGHT

Arm length	MONO BOOM			
	2,4 m		2,9 m	
Material weight up to 1,2 t/m ³	1,68 m ³	1.200 kg	1,65 m ³	1.150 kg
Material weight up to 1,5 t/m ³	1,53 m ³	1.100 kg	1,40 m ³	1.025 kg
Material weight up to 1,8 t/m ³	1,30 m ³	1.000 kg	1,22 m ³	925 kg

Max. capacity and weight have been calculated according to ISO 10567:2007.

Please consult with your distributor for the correct selection of buckets and attachments to suit the application.

BUCKET AND ARM FORCE

Arm length	2,4 m	2,9 m
Bucket digging force	16.500 kg	14.100 kg
Bucket digging force at PowerMax	17.500 kg	15.200 kg
Arm crowd force	12.200 kg	10.300 kg
Arm crowd force at PowerMax	13.000 kg	11.000 kg

Working Range



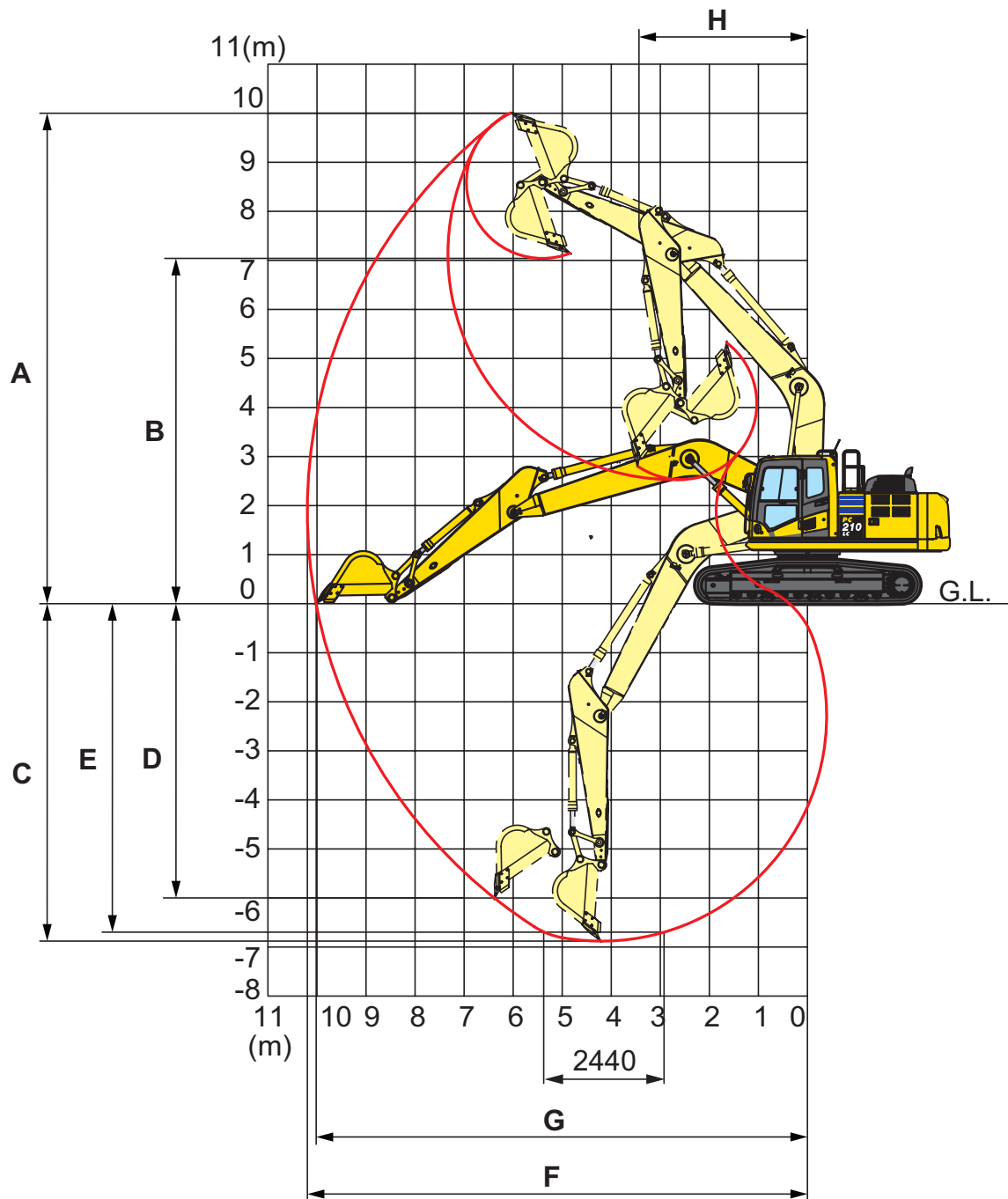







MONO BOOM



ARM LENGTH	2,4 m	2,9 m
A Max. digging height	9.800 mm	10.000 mm
B Max. dumping height	6.890 mm	7.110 mm
C Max. digging depth	6.095 mm	6.620 mm
D Max. vertical wall digging depth	5.430 mm	5.980 mm
E Max. digging depth of cut for 2,44 m level	5.780 mm	6.370 mm
F Max. digging reach	9.380 mm	9.875 mm
G Max. digging reach at ground level	9.190 mm	9.700 mm
H Min. swing radius	3.090 mm	3.040 mm



PC210-10 MONO BOOM

Arm length	A		7,5 m		6,0 m		4,5 m		3,0 m		1,5 m	
	B											

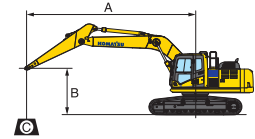

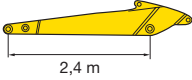

	7,5 m	kg	*6.100	5.900								
	6,0 m	kg	*5.700	4.300			*6.020	5.150	*6.240	*6.240		
	4,5 m	kg	5.080	3.620			*6.520	5.010	*7.600	*7.600	*10.410	*10.410
	3,0 m	kg	4.640	3.290	4.930	3.500	6.850	4.790	*9.530	7.100		
	1,5 m	kg	4.500	3.180	4.830	3.400	6.620	4.580	10.110	6.670		
	0,0 m	kg	4.630	3.250	4.760	3.340	6.460	4.440	9.880	6.480		
	- 1,5 m	kg	5.090	3.560			6.420	4.400	9.850	6.450	*12.410	12.060
	- 3,0 m	kg	6.240	4.310			6.510	4.480	9.960	6.540	*14.520	12.270

A – Reach from swing center

B – Bucket hook height

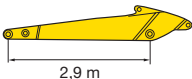
C – Lifting capacities

	7,5 m	kg	*4.060	*4.060			*4.660	*4.660						
	6,0 m	kg	*3.820	*3.820			*5.430	5.210						
	4,5 m	kg	*3.800	3.290	5.050	3.600	*6.010	5.050	*6.810	*6.810				
	3,0 m	kg	*3.930	3.010	4.940	3.500	6.890	4.810	*8.760	7.220				
	1,5 m	kg	4.130	2.910	4.810	3.380	6.620	4.580	10.180	6.720				
	0,0 m	kg	4.220	2.960	4.720	3.290	6.430	4.400	9.860	6.440	*7.200	*7.200		
	- 1,5 m	kg	4.570	3.190	4.690	3.270	6.350	4.330	9.760	6.360	*11.680	*11.680	*7.480	*7.480
	- 3,0 m	kg	5.420	3.750			6.380	4.360	9.820	6.410	*15.550	12.010	*12.100	*12.100
	- 4,5 m	kg	*7.280	5.230					*9.020	6.620	*12.560	12.380		

 – Rating over front

 – Rating over side

 – Rating at maximum reach

With 600 mm shoes











Weights:

With 2,4 m arm: bucket linkage and bucket cylinder: 359 kg

With 2,9 m arm: bucket linkage and bucket cylinder: 335 kg

* Load is limited by hydraulic capacity rather than tipping. Ratings are based on SAE Standard No. J1097. Rated loads do not exceed 87% of hydraulic lift capacity or 75% of tipping load. Lifting capacity stated is based on lifting with bare arm. When lifting with additional equipment installed to the arm, please subtract the weight of all additional equipment from the values stated.

PC210LC-10 MONO BOOM

Arm length	A		7,5 m		6,0 m		4,5 m		3,0 m		1,5 m	
	B											

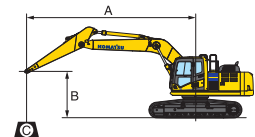

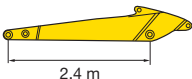

	7,5 m	kg	*6.100	*6.100								
	6,0 m	kg	*5.700	4.780			*6.020	5.710	*6.240	*6.240		
	4,5 m	kg	*5.660	4.030			*6.520	5.570	*7.600	*7.600	*10.410	*10.410
	3,0 m	kg	5.470	3.670	5.810	3.900	*7.370	5.340	*9.530	7.980		
	1,5 m	kg	5.320	3.560	5.710	3.810	7.890	5.130	*11.140	7.540		
	0,0 m	kg	5.470	3.640	5.640	3.740	7.730	4.990	*11.820	7.340		
	- 1,5 m	kg	6.040	3.990			7.690	4.950	*11.640	7.310	*12.410	*12.410
	- 3,0 m	kg	7.450	4.840			7.780	5.030	*10.600	7.410	*14.520	14.180

A – Reach from swing center

B – Bucket hook height

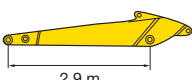
C – Lifting capacities

	7,5 m	kg	*4.060	*4.060			*4.660	*4.660						
	6,0 m	kg	*3.820	*3.820			*5.430	*5.430						
	4,5 m	kg	*3.800	3.660	*5.680	4.010	*6.010	5.620	*6.810	*6.810				
	3,0 m	kg	*3.930	3.360	5.830	3.900	*6.920	5.370	*8.760	8.100				
	1,5 m	kg	*4.210	3.260	5.700	3.790	*7.850	5.130	*10.570	7.590				
	0,0 m	kg	*4.720	3.320	5.600	3.700	7.710	4.950	*11.570	7.300	*7.200	*7.200		
	- 1,5 m	kg	5.420	3.580	5.570	3.670	7.620	4.880	*11.700	7.220	*11.680	*11.680	*7.480	*7.480
	- 3,0 m	kg	6.450	4.220			7.650	4.910	*11.010	7.270	*15.550	13.920	*12.100	*12.100
	- 4,5 m	kg	*7.280	5.890					*9.020	7.490	*12.560	*12.560		

 – Rating over front

 – Rating over side

 – Rating at maximum reach

With 600 mm shoes

Weights:

With 2,4 m arm: bucket linkage and bucket cylinder: 359 kg

With 2,9 m arm: bucket linkage and bucket cylinder: 335 kg

* Load is limited by hydraulic capacity rather than tipping. Ratings are based on SAE Standard No. J1097. Rated loads do not exceed 87% of hydraulic lift capacity or 75% of tipping load. Lifting capacity stated is based on lifting with bare arm. When lifting with additional equipment installed to the arm, please subtract the weight of all additional equipment from the values stated.

Super Long Front Specification

MACHINE DIMENSIONS		PC210LC-10
A	Overall width of upper structure	2.705 mm
B	Overall height of cab	3.045 mm
C	Overall length of basic machine	5.135 mm
D	Tail length	2.910 mm
	Tail swing radius	2.940 mm
E	Clearance under counterweight	1.085 mm
F	Machine tail height	2.280 mm
G	Ground clearance	440 mm
H	Tumbler centre distance	3.655 mm
I	Track length	4.450 mm
J	Track gauge	2.380 mm
K	Track shoe width	600, 700, 800, 900 mm
L	Overall track width with 600 mm shoes	2.980 mm
	Overall track width with 700 mm shoes	3.080 mm
	Overall track width with 800 mm shoes	3.180 mm
	Overall track width with 900 mm shoes	3.280 mm

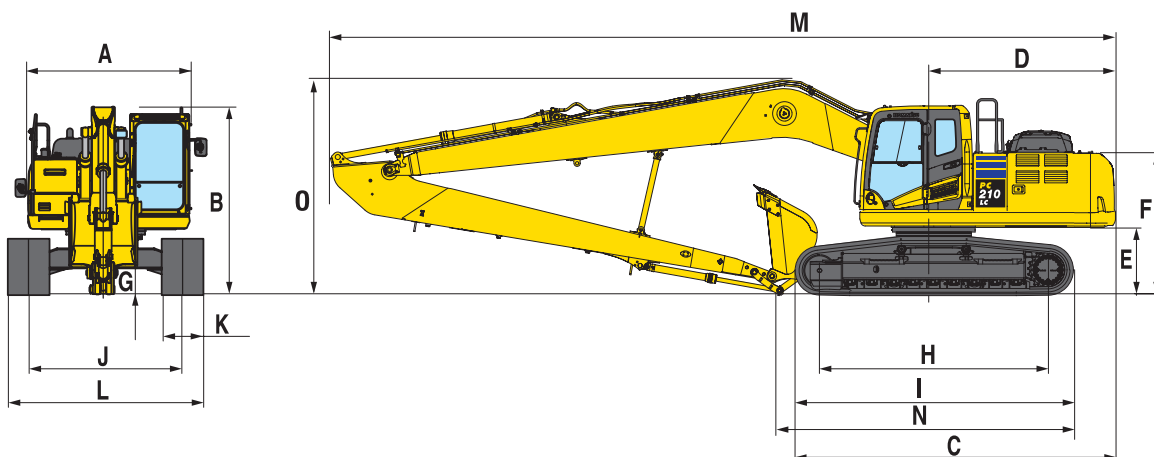

TRANSPORT DIMENSIONS

	Arm length	8.795 mm
	Boom length	7.375 mm
M	Transport length	12.940 mm
N	Length on ground (transport)	4.705 mm
O	Overall height (to top of boom)	3.475 mm

OPERATING WEIGHT (APPR.)

Triple grouser shoes	Operating weight	Ground pressure
600 mm	23.220 kg	0,49 kg/cm ²
700 mm	23.490 kg	0,42 kg/cm ²
800 mm	23.810 kg	0,38 kg/cm ²
900 mm	24.080 kg	0,34 kg/cm ²

Operating weight, including Super Long Front work equipment, bucket, operator, lubricant, coolant, full fuel tank and the standard equipment.

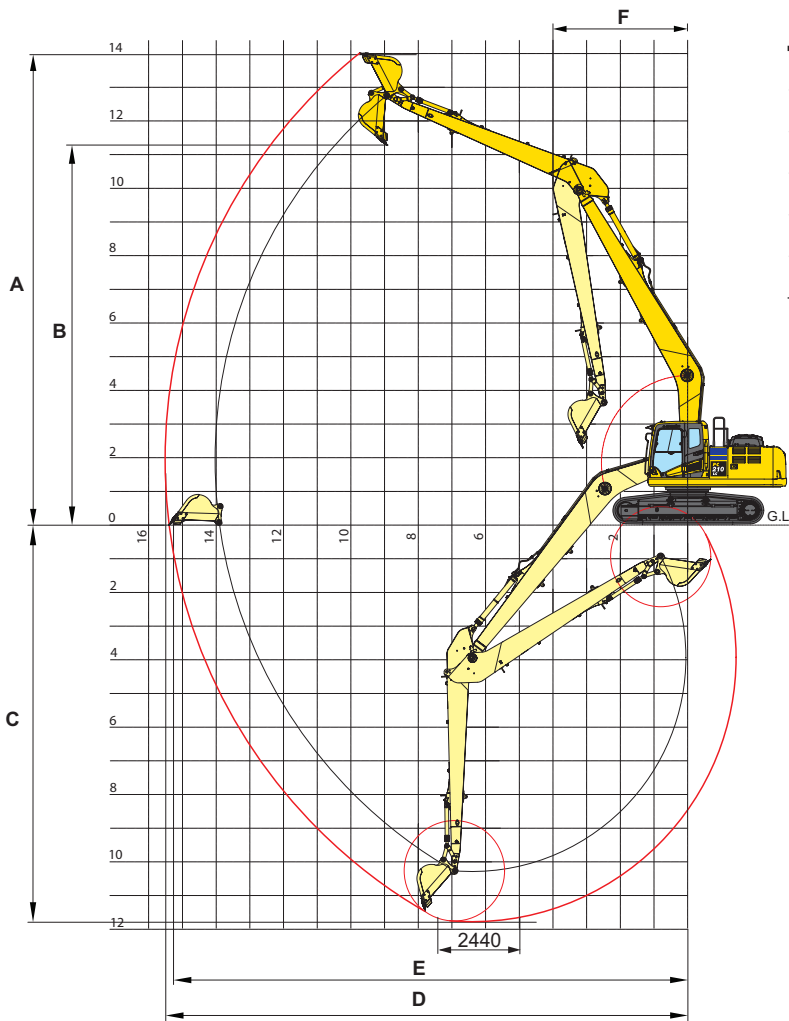

WORKING RANGE

A	Max. digging height	13.980 mm
B	Max. dumping height	11.240 mm
C	Max. digging depth	11.790 mm
D	Max. digging reach	15.435 mm
E	Max. digging reach at ground level	15.340 mm
F	Min. swing radius	4.000 mm

MAX. BUCKET CAPACITY AND WEIGHT

	General purpose bucket	Ditch cleaning bucket
Max. bucket width	955 mm	2.100 mm
Material weight up to 1,2 t/m ³	0,66 m ³ 525 kg	* 1.300 kg
Material weight up to 1,5 t/m ³	0,56 m ³ 475 kg	* 1.300 kg
Material weight up to 1,8 t/m ³	0,49 m ³ 425 kg	-

* Maximum load at end of arm (bucket + payload). Max. capacity and weight have been calculated according to ISO 10567:2007. Please consult with your distributor for the correct selection of buckets and attachments to suit the application.

LIFTING CAPACITY WITH 600 MM SHOES

A	⊕		14,0 m		12,0 m		10,0 m		8,0 m		6,0 m	
	⊕	⊖	⊕	⊖	⊕	⊖	⊕	⊖	⊕	⊖	⊕	⊖
13,0 m	kg *800	*800										
10,0 m	kg *660	*660					*1.630	*1.630				
6,0 m	kg *650	*650			*1.820	1.820	*1.920	*1.920				
3,0 m	kg *720	*720	*1.510	1.050	*2.110	1.580	*2.410	2.340	*2.900	*2.900	*3.800	*3.800
0,0 m	kg *870	850	1.640	910	2.210	1.330	*2.950	1.900	*3.800	2.750	*5.450	4.200
-3,0 m	kg *1.160	890			2.030	1.150	2.720	1.610	3.800	2.300	5.900	3.500
-6,0 m	kg *1.770	1.130					2.650	1.540	3.700	2.150	5.800	3.400
-9,0 m	kg *2.940	1.890							*3.750	2.400	*5.200	3.800

* Load is limited by hydraulic capacity rather than tipping. Ratings are based on SAE Standard No. J1097. Rated loads do not exceed 87% of hydraulic lift capacity or 75% of tipping load. Lifting capacity table is published for guidance only, the machine is not intended for use as a crane.

Hydraulic Excavator

PC210/LC-10

Standard and Optional Equipment

ENGINE

Komatsu SAA6D107E-2 turbocharged common rail direct injection diesel engine	●
EU Stage IIIB compliant	●
Suction type cooling fan with radiator fly screen	●
Automatic engine warm-up system	●
Engine overheat prevention system	●
Fuel control dial	●
Auto-deceleration function	●
Engine key stop	●
Engine ignition can be password secured on request	●
Alternator 24 V/60 A	●
Starter motor 24 V/5,5 kW	●
Batteries 2 × 12 V/155 Ah	●

HYDRAULIC SYSTEM

Electronic closed-centre load sensing (E-CLSS) hydraulic system (HydrauMind)	●
Pump and engine mutual control (PEMC) system	●
One additional hydraulic circuit	●
6-working mode selection system; power mode, economy mode, breaker mode, attachment power and attachment economy mode, and lifting mode	●
PowerMax function *	●
Adjustable PPC wrist control levers for arm, boom, bucket and swing, with sliding proportional control for attachments and 3 auxiliary buttons	●
Prepared for hydraulic quick-coupler *	●
Additional hydraulic functions *	○

WORK EQUIPMENT

Mono boom	○
Super Long Front boom and arm (15 m) (LC only)	○
2,4 m; 2,9 m arms	○
Bucket linkage with lifting eye	○
Komatsu buckets	○
Komatsu breakers	○

* not available with Super Long Front

CABIN

Reinforced safety SpaceCab™; highly pressurised and tightly sealed hyper viscous mounted cab with tinted safety glass windows, large roof window with sun shade, pull-up type front window with locking device, removable lower window, front window wiper with intermittent feature, sun roller blind, cigarette lighter, ashtray, luggage shelf, floor mat	●
Heated, high back air suspension seat with lumbar support, console mounted height adjustable arm rests, and retractable seat belt	●
Automatic climate control system	●
12/24 Volt power supplies	●
Beverage holder and magazine rack	●
Hot and cool box	●
Radio	●
Auxiliary input (MP3 jack)	●
Lower wiper	○
Rain visor (not with OPG)	○

SERVICE AND MAINTENANCE

Automatic fuel line de-aeration	●
Double element type air cleaner with dust indicator and auto dust evacuator	●
KOMTRAX™ - Komatsu wireless monitoring system	●
Multi-function video compatible colour monitor with Equipment Management and Monitoring System (EMMS) and efficiency guidance	●
Toolkit	●
Komatsu CARE™	●
Service points	○
Automatic greasing system	○

UNDERCARRIAGE

Track roller guards	●
Track frame under-guards	●
600, 700, 800, 900 mm triple grouser shoes	○
Full length track roller guards	○

SAFETY EQUIPMENT

Rear view camera system	●
Electric horn	●
Overload warning device	●
Audible travel alarm	●
Boom safety valves	●
Large handrails, rear-view mirrors	●
Battery main switch	●
ROPS compliant to ISO 12117-2:2008	●
Emergency engine stop switch	●
Arm safety valve *	●
OPG Level II front guard (FOPS), hinged type	○
OPG Level II top guard (FOPS)	○
Additional camera, right side mounted	○

DRIVES AND BRAKES

Hydrostatic, 3-speed travel system with automatic shift and planetary gear type final drives, and hydraulic travel and parking brakes	●
PPC control levers and pedals for steering and travel	●

LIGHTING SYSTEM

Working lights: 2 revolving frame, 1 boom (l.h.)	●
Additional working lights: 4 cab roof (front), 1 cab roof (rear), 1 boom (r.h.), 1 counterweight (rear), beacon	○

OTHER EQUIPMENT

Standard counterweight	●
Heavy counterweight (Super Long Front only)	●
Remote greasing for swing circle and pins	●
Electric refuelling pump with automatic shut-off function	●
Biodegradable oil for hydraulic system	○
Customised paint	○
Komatsu-Topcon guidance system preparation	○

Further equipment on request

- standard equipment
- optional equipment

Your Komatsu partner:

KOMATSU

Komatsu Europe International N.V.
 Mechelsesteenweg 586
 B-1800 VILVOORDE (BELGIUM)
 Tel. +32-2-255 24 11
 Fax +32-2-252 19 81
www.komatsu.eu

UENSS16506 02/2017

Materials and specifications are subject to change without notice.
KOMATSU is a trademark of Komatsu Ltd. Japan.